

# *wirquin*

SANITARY EQUIPMENT SPECIALIST



# Breson

# The Wirquin Group

A FRENCH GROUP ESTABLISHED WORLDWIDE



**1977**

CREATION  
OF THE FIRST  
MANUFACTURING  
PLANT



**10**

SUBSIDIARIES



**6**

PRODUCTION SITES



**1400**

WORLDWIDE  
WORKFORCE

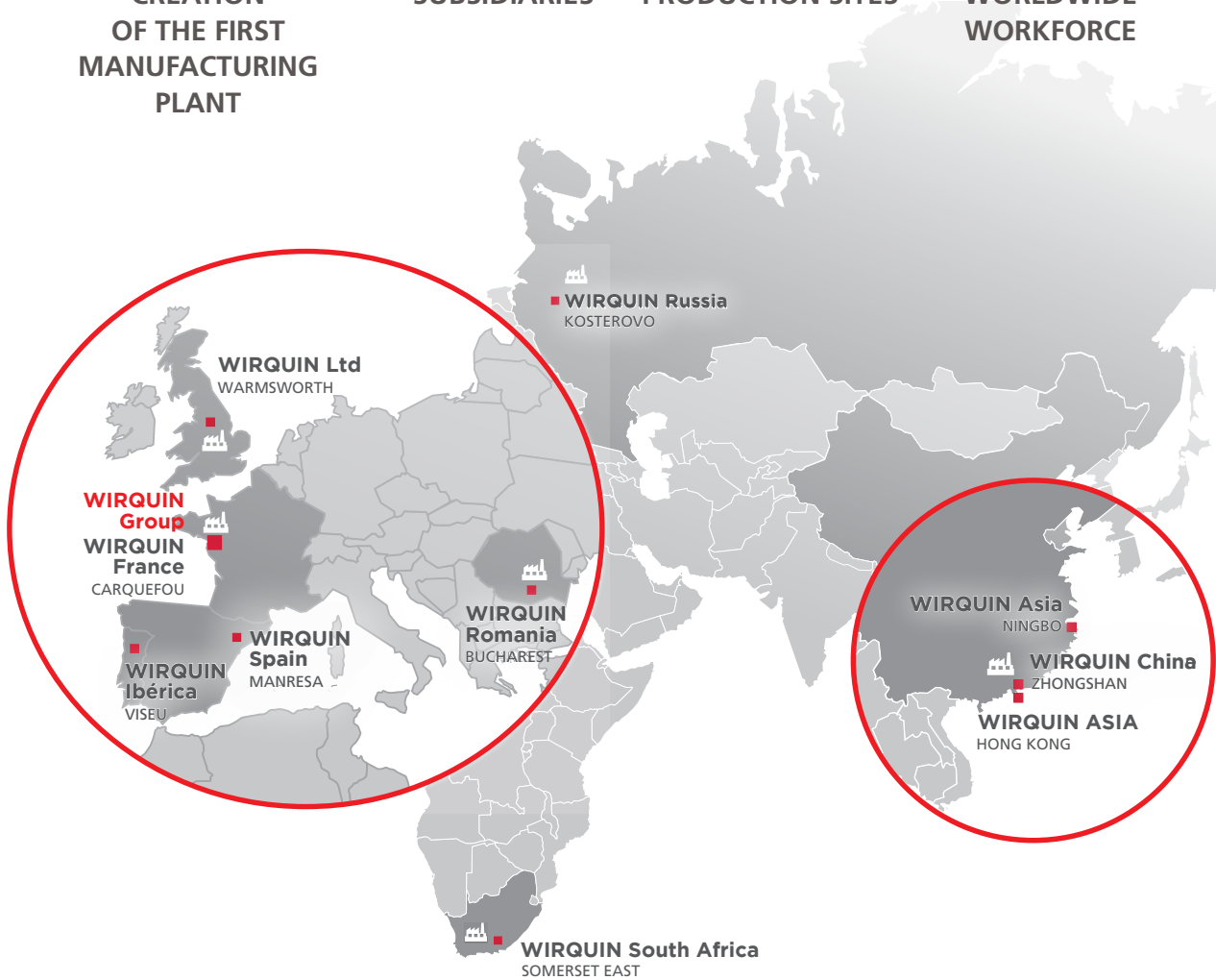

## INNOVATION IS IN OUR DNA

Wirquin annually invests more than 5% of its revenue in R&D. This enables us to market our products in over 60 countries.

# Our Brands

To meet the market demands, **Wirquin** has developed several brands. Based on this strategy, the group has increased its presence on the sanitary equipment market and optimises the relevance of its product offering with the final customer.



Via our brands, we make a promise when it comes to:

## TECHNOLOGY

At Wirquin, **innovation** is a driving force. Each new product is designed to:

- ▶ **improve performance**
- ▶ **save space**
- ▶ **save time**
- ▶ **be easy to install**
- ▶ **improve the look of any bathroom or kitchen thanks to a contemporary design and a smaller footprint.**

## SERVICE

With our strong customer focus, we do everything in our power to provide full support and satisfaction. **We promise to provide our distributors, installers, OEM customers and users** with agile, top-quality services for **optimum efficiency**.

We stock spare parts for 10 years beyond our warranty period, for worry-free long-term after-sales service.

## QUALITY

All our innovations not only meet all quality standards but are also tested and inspected by a team of technicians, under real use conditions, before being released on the market. Wirquin promises to deliver **products that are 100% reliable**.

# Quality

## CERTIFIED WIRQUIN QUALITY

Some of our products comply with all the requirements of the following standards (technical tests and ongoing audits):



NF\*



UPC\*



WaterMark

WaterMark\*



WCC\*



WRAS\*

## THE ECOLABELS

Wirquin is committed to promoting products from sustainably managed supply chains. Our FSC and PEFC certifications guarantee that some of our wood-based products come from a supply chain controlled end-to-end, from the raw material to the finished product.



## CERTIFIED INDUSTRIAL PLANTS

All our production sites are ISO 9001 certified (quality management) and a process is underway for ISO14001 (environmental management) and OSHAS 18001 (occupational health and safety management) certification by 2020.



WIRQUIN SOUTH AFRICA



WIRQUIN CHINA



WIRQUIN FRANCE



WIRQUIN LTD



WIRQUIN ROMANIA



WIRQUIN RUSSIA

\* certified products indicated in the catalogue.

# Wirquin Export

**OUR INTERNATIONAL TEAM THINKS GLOBALLY AND ACTS LOCALLY**

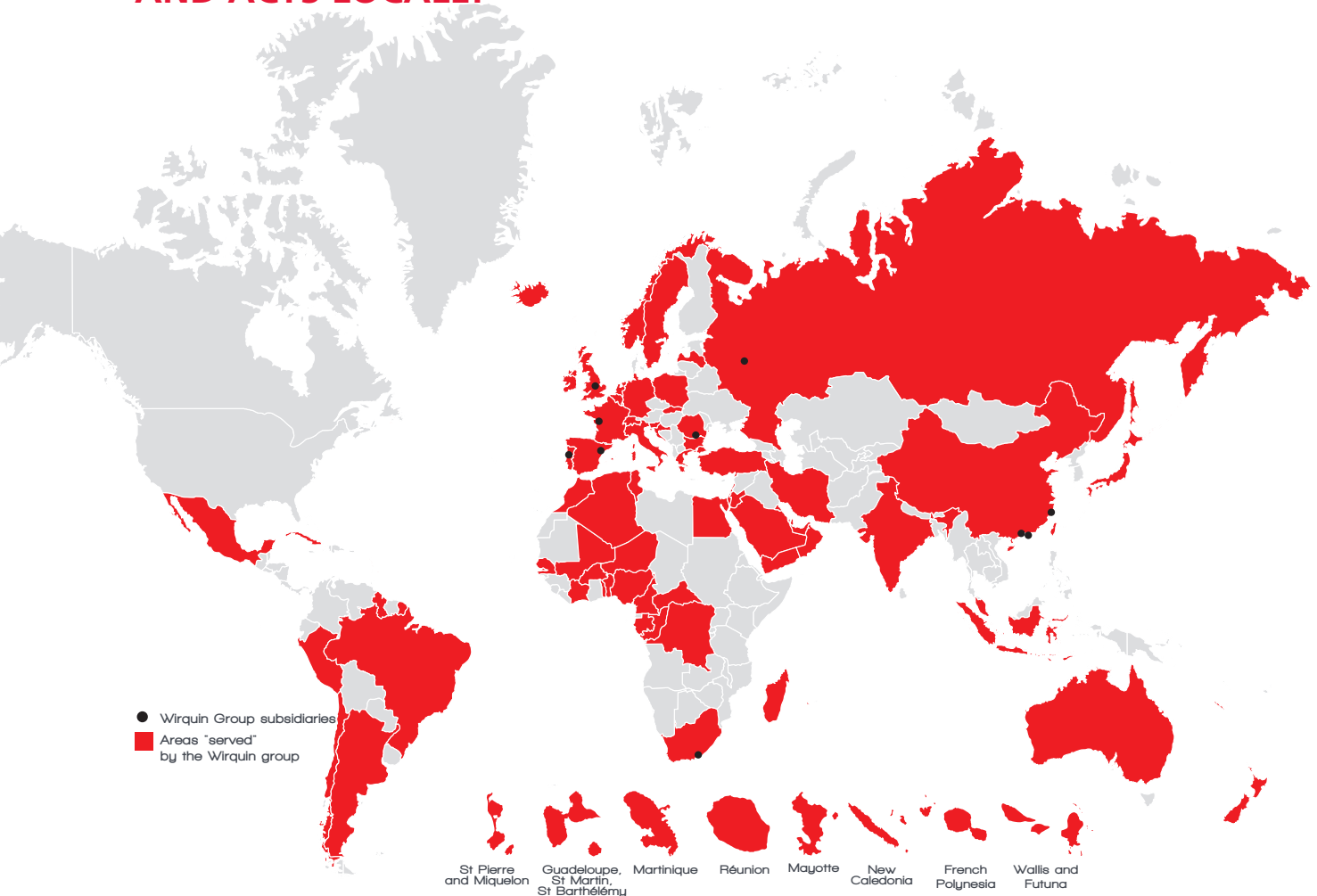

**1977:** Creation of WIRQUIN Plastiques S.A. with industrial facilities in Carquefou, France.

**1995:** Creation of a distribution subsidiary, WIRQUIN CALAF in Spain.

**1999:** Acquisition of URBIS SANITAR (Romania) which became WIRQUIN ROMANIA.

**2004:** Creation of WIRQUIN SOUTH AFRICA.

**2005:** Creation of WIRQUIN RUS (Russia). Creation of the joint venture GOLDEN PLASTIC INDUSTRIAL (China).

**2006:** Creation of WIRQUIN MANUFACTURING in South Africa.

**2007:** WIRQUIN Plastiques is certified ISO 9001. Creation of WIRQUIN ASIA (HK) with an office in Ningbo (PRC).

**2009:** Wirquin Plastiques is certified ISO 14001. Acquisition of AIMAS (Zhongshan China), 3<sup>rd</sup> largest Chinese manufacturer of toilet seats, flushing mechanisms, toilet valves and cisterns.

**2011:** Acquisition of CME Sanitary Systems (UK), which becomes WIRQUIN LTD, manufacturer of toilet seats and flushing mechanisms, UK market leader.

**2012:** Merger of the two South African entities to create WIRQUIN MANUFACTURING SOUTH AFRICA.

**2013:** Acquisition of the Russian company VIRPLAST and merger with WIRQUIN RUS.

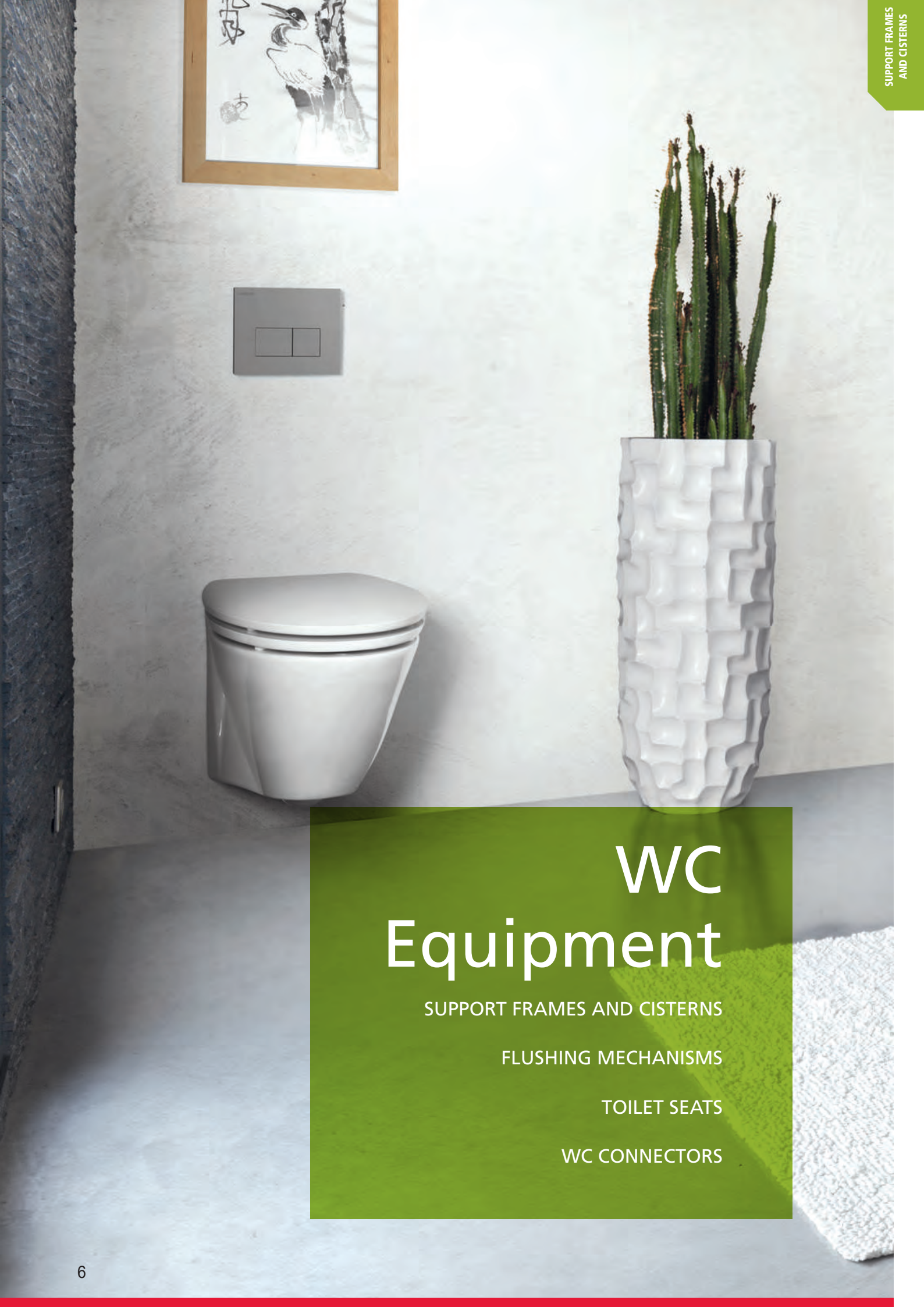

# WC Equipment

SUPPORT FRAMES AND CISTERNS

FLUSHING MECHANISMS

TOILET SEATS

WC CONNECTORS

## Complete HARMONY pack Ø 100 mm



Reference	<b>WR55721929</b>
Ean-13 code	3375537218486
Packaging	2 boxes
Multiple / Boxed qty.	02/04
Mounting	Self-supporting.
Structure	Supports 400 kg.
Flush system	Dual-flush mechanism. Cable system
Flush control plate	"Lune" matt chromed plate included.
Adjustable pan height	Pan, included, rimless, with ultra-slide and anti-bacterial treatment.

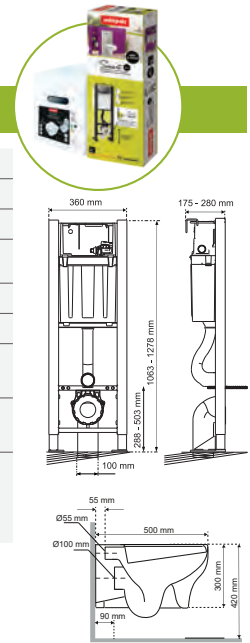

## Complete GLASSY pack Ø 100 mm



Reference	<b>WR55722256</b>
Ean-13 code	3375537221776
Packaging	2 boxes
Multiple / Boxed qty.	01/04
Mounting	Self-supporting.
Structure	Supports 400 kg.
Flush system	Dual-flush mechanism. Cable system
Flush control plate	"Lune" matt chromed plate included.
Adjustable pan height	Easy to clean pan, included, rimless.

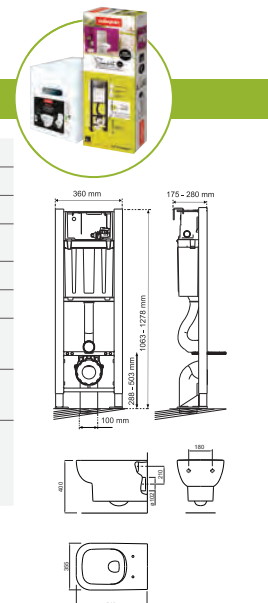

## LOW-LEVEL cistern with soft close seat



Reference	<b>WR7125CK</b>
Multiple / Boxed qty	<b>01</b>
Water-saving button	<ul style="list-style-type: none"> <li>▶ <b>Chromed push button.</b></li> <li>▶ <b>Dual flush.</b></li> </ul>
Design	▶ <b>Hi-gloss ceramic finish plastic.</b>
Assembly / connection	<ul style="list-style-type: none"> <li>▶ <b>Adjustable wall mounts.</b></li> <li>▶ <b>Flush Pipe included.</b></li> </ul>
Main Features	<ul style="list-style-type: none"> <li>▶ <b>Equipped with a water-saving mechanism.</b></li> <li>▶ <b>Soft close seat.</b></li> <li>▶ <b>Float valve 1/2".</b></li> </ul>

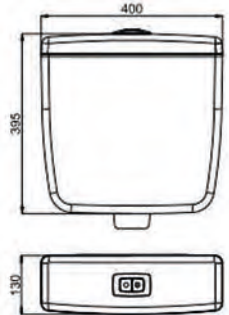





# A complete range of of **FLUSH MECHANISMS**



## MW<sup>2</sup> water-saving mechanism with cable



Reference	<b>WR14010203</b>
Ean-13 code	3375537140695
Packaging	Box
Multiple / Boxed qty	01/16
Cistern height	270 to 440 mm
Diam. of lid hole	14 to 46 mm
Mecanism control	Cable
Main Features	► Automatically adjusts to the cistern height.

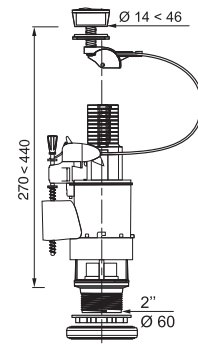

## 100% hygienic Discover the WC TRONIC 2



Infrared flush control system. For total control of flush volume.

### Product advantages

- + 100% hygienic: hands-free flushing.
- + Intuitive: infrared detection.
- + Control your water consumption: just place your hand over the blue sensor and the toilet flushes. Move your hand away to stop the flush.
- + Easy assembly: adjusts automatically thanks to the cable.

## WC TRONIC 2 water-saving mechanism with cable



Reference	<b>WR10719338</b>
Ean-13 code	3375537192663
Packaging	Blister
Multiple / Boxed qty	01/18
Cistern height	320 to 420 mm
Diam. of lid hole	Ø 38 to 45 mm
Mecanism control	Cable

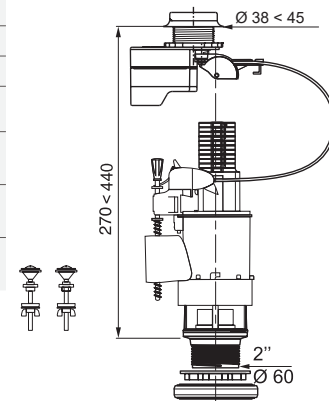

## Mechanism 4259 mechanical dual flush



Reference	<b>WR4259</b>
Packaging	Bag
Multiple / Boxed qty	01
Cistern height	289 to 427 mm
Dia. of lid hole	14 to 58 mm
Mechanism control	With push button
Main Features	► 2" For close-coupled or single-unit toilets

# Smart fill Wirquin Pro



The smart float can delay tank filling for optimum efficiency. Thanks to its delayed action technology, it only releases water when the mechanism is fully closed. This saves up to 6L of water per day (for a family of 4).

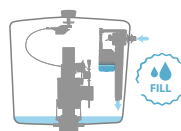
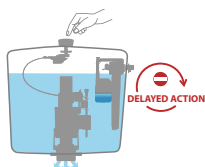

## WIRQUIN PRO

### 1/2" PLASTIC



Reference	<b>WR16300101</b>
Ean-13 code	3375537150151
Packaging	Box
Multiple / Boxed qty	01/36
Fitting	1/2" plastic
Flow rate at 3 bars	10 L/min
Operating range	0.1 to 16 bars. Withstands pressure spikes to 20 bars.
Water level adjustment	By screw.
Main features	<ul style="list-style-type: none"> <li>▶ 180° rotating head.</li> <li>▶ Ideal for narrow ceramic cisterns (patent).</li> <li>▶ Copes with water containing impurities.</li> <li>▶ Very quiet (17 dbA).</li> <li>▶ Delayed action: water saving.</li> </ul>

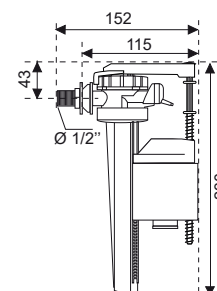

### 1/2" BRASS



Reference	<b>WR16300201</b>
Ean-13 code	3375537150410
Packaging	Box
Multiple / Boxed qty	01/36
Fitting	1/2" brass
Flow rate at 3 bars	10 L/min
Operating range	0.1 to 16 bars. Withstands pressure spikes to 20 bars.
Water level adjustment	By screw.
Main features	<ul style="list-style-type: none"> <li>▶ 180° rotating head.</li> <li>▶ Ideal for narrow ceramic cisterns (patent).</li> <li>▶ Copes with water containing impurities.</li> <li>▶ Very quiet (17 dbA).</li> <li>▶ Delayed action: water saving.</li> </ul>

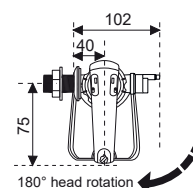

## WIRQUIN PRO telescopic

**1/2" PLASTIC**

Reference	<b>WR16110101</b>
Ean-13 code	3375537151691
Packaging	Box
Multiple / Boxed qty	01/36
Fitting	1/2" plastic
Flow rate at 3 bars	11.6 L/min
Operating range	0.1 to 16 bars Withstands pressure spikes to 20 bars.
Water level adjustment	By screw.
Main Features	<ul style="list-style-type: none"> <li>▶ Telescopic: adjusts to the height of the cistern in just seconds.</li> <li>▶ Very quiet.</li> <li>▶ Copes with water containing impurities.</li> <li>▶ Delayed action: water saving.</li> </ul>

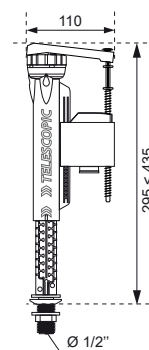
**1/2" BRASS**

Reference	<b>WR16110201</b>
Ean-13 code	3375537150434
Packaging	Box
Multiple / Boxed qty	01/36
Fitting	1/2" brass
Flow rate at 3 bars	3.1 L/min at 0.1 bars
Operating range	0.1 to 16 bars. Withstands pressure spikes to 20 bars.
Water level adjustment	By screw.
Main Features	<ul style="list-style-type: none"> <li>▶ Telescopic: adjusts to the height of the cistern in just seconds.</li> <li>▶ Very quiet.</li> <li>▶ Copes with water containing impurities.</li> <li>▶ Locks in place.</li> <li>▶ Delayed action: water saving.</li> </ul>

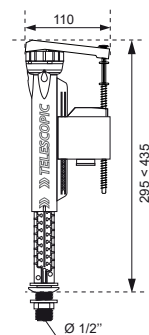

## ACCESSORIES

## M36 foam seal 110 X 70 X 26



Reference	<b>WRM36</b>
Ean-13 code	3375536005490
Packaging	Bulk
Multiple / Boxed qty	01/300

## Flush Valve Washer



Reference	<b>WR10717797</b>
Ean-13 code	3375537177646
Packaging	Bag
Multiple / Boxed qty	01/750

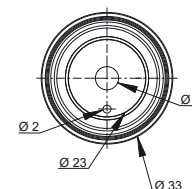



# TOILET SEATS

## *Classic Range:*

- ▶ *Thermoplastic*
- ▶ *Thermoset*



INTERNATIONAL



Reference	<b>WR20722783</b>
Ean-13 code	3375537226672
Packaging	Film
Multiple / Boxed qty.	100
Weight	1 kg
Colour	White
Hinges / Screws	Bottom Fix Hinge - Lock+
Special Features	<ul style="list-style-type: none"> <li>▶ Lock+ System prevents the seat from moving.</li> <li>▶ Unbreakable.</li> <li>▶ Independent hinges: better hygiene.</li> <li>▶ Ideal for renovation.</li> <li>▶ Antistatic.</li> </ul>

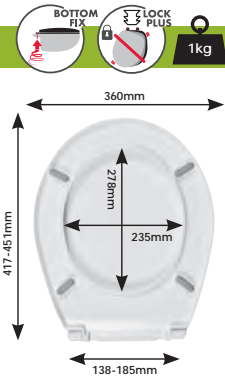

MELODY Modufix



Reference	<b>WR20721920</b>
Ean-13 code	3375537218394
Packaging	Box
Multiple / Boxed qty.	01/05
Weight	1.5 kg
Colour	White
Hinges / Screws	Plastic hinges.
Special Features	▶ Anti-bacterial treatment.



Upgradeable hinges for Melody.

SOFT CLOSE chromed hinges



Reference	<b>WR20721923</b>
Ean-13 code	3375537218424
Packaging	Box
Multiple / Boxed qty.	01/08
Screws	Stainless steel
Special Features	<ul style="list-style-type: none"> <li>▶ Lock+ System prevents the seat from moving.</li> <li>▶ TOPFIX: screws installed from the top.</li> <li>▶ SOFT CLOSE: slow closing.</li> <li>▶ Quick release: easy cleaning.</li> </ul>



ARENA



Reference	<b>WR20721589</b>
Ean-13 code	3375537215188
Packaging	Box
Multiple / Boxed qty.	01/04
Weight	2.1 kg
Colour	White
Hinges / Screws	Plastic hinges and screws.
Special Features	<ul style="list-style-type: none"> <li>▶ Soft close system.</li> <li>▶ Back piece: prevents lateral movements.</li> </ul>



Plunger pump Ø 7 cm and Ø 16 cm



Reference	<b>WR20720614</b>
Ean-13 code	3375537205394
Packaging	Bulk
Multiple / Boxed qty.	01/25

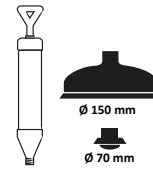



## A complete range of WC CONNECTORS

- ▶ *Flexible*
- ▶ *Extendable*
- ▶ *Rigid*





PAN OUTLET, straight



Reference	<b>WRA372</b>
Ean-13 code	3375530086419
Packaging	Bulk
Multiple / Boxed qty	01/60
Features	<ul style="list-style-type: none"> <li>▶ Pan outlet: Ø 100 to 105 mm</li> <li>▶ Length: 95 mm</li> </ul>

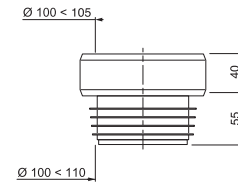

PAN OUTLET, offset



Reference	<b>WRA374</b>
Ean-13 code	3375530086815
Packaging	Bulk
Multiple / Boxed qty	01/60
Features	<ul style="list-style-type: none"> <li>▶ Pan outlet: Ø 100 to 105 mm</li> <li>▶ Length: 95 mm</li> <li>▶ Offset: 19 mm</li> </ul>

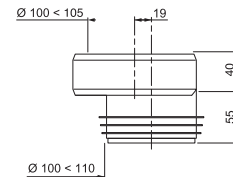

FLEXIBLE CONNECTOR Push-Fit - L 130 mm - offset outlet push-fit: 4 cm



Reference	<b>WR70721627</b>
Ean-13 code	3375537215560
Packaging	Bag
Multiple / Boxed qty	01/33
Pipework connection	Ø 100/110 m

JOLLYFLEX Push-Fit



LONG - 320 - 540 MM

Reference	<b>WR71080001</b>
Ean-13 code	3375536038986
Packaging	Film
Multiple / Boxed qty	12
Pan outlet	Ø 80 < Ø 105 mm
Pipework connection	Ø 104 < Ø 110 mm push-fit

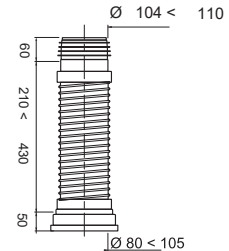

SHORT - 240 - 390 MM

Reference	<b>WR71080101</b>
Ean-13 code	3375536038979
Packaging	Film
Multiple / Boxed qty	01/15
Pan outlet	Ø 80 < Ø 105 mm
Pipework connection	Ø 104 < Ø 110 mm push-fit

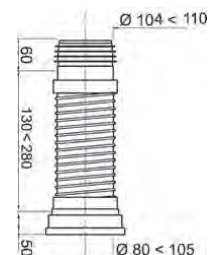

EXTENDABLE PIPE with metal reinforcement - Push-Fit



Reference	<b>WR71260101</b>
Ean-13 code	3375537142224
Packaging	Film
Multiple / Boxed qty	01/20
Centreline distance	260 to 650 mm
Pan outlet	Ø 80 < Ø 105 mm
Pipework connection	Ø 104 < Ø 110 mm push-fit

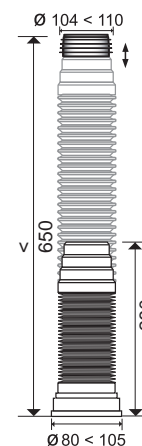



# Waste Systems

FOR WALK-IN SHOWERS

SHOWER

BATH

SINK

WASHBASIN

CONNECTORS

# VENISIO EXPERT

## High Tech with Style



Decidedly top-of-the-range, VENISIO EXPERT is the first shower channel on the market to use a self-contained trough with trap.

### Product advantages

- + Self-contained trough with trap.
- + Brushed stainless steel grid.
- + Direct access to the trap.
- + Peripheral sealing system.

### VENISIO EXPERT, complete pack with channel + reversible grid

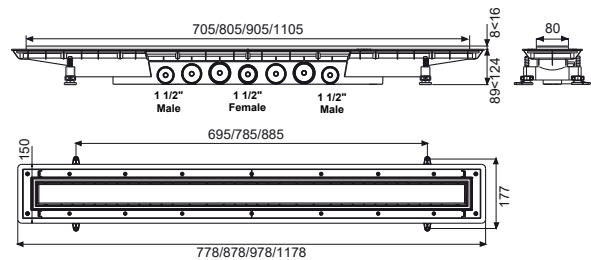

Description	Linear channel			
Reference	WR30718077	WR30718078	WR30718079	WR30718606
Ean-13 Code	3375537180363	3375537180370	3375537180387	3375537185559
Packaging	Box	Box	Box	Box
Boxed Quantity	01	01	01	01
Length	700 mm	800 mm	900 mm	1100 mm
Height	89 mm			
Depth of Seal	50 mm			
Flow Rate in L/PM (UNDER 20mm OF WATER)	Up to 79 L/mn			
Outlet	2 x Ø43 mm male + 1 x Ø43 mm female			
Grid	Brushed Stainless Steel or Tile Finish			





## A complete range of **SHOWER** wastes and trays

- ▶ *Low-profile wastes*
- ▶ *Wastes for installation on screed*
- ▶ *Wastes Ø 90*



# WASTES FOR INSTALLATION ON SCREED

## The screed solution



The JAMES wastes for installation on screed are economical and watertight solutions thanks to a pre-glued sealing membrane for successful walk-in shower projects.

### Product advantages

- + An economical, watertight solution
- + Levelling shim to adapt to mosaic and tile for a perfect fit.
- + Trap to fit all configurations.
- + High performance flow rate greater than standard requirements.

### JAMES swivelling waste for installation on screed

OUTLET  
SWIVELS  
360°



Reference	<b>WR30722012</b>
Ean-13 code	3375537219315
Packaging	Box
Multiple / Boxed qty	01/06
Height	93 mm (installed horizontally) 136 mm (installed vertically)
Water seal	50 L/min
Grid	Designer 115 x 115 mm brushed stainless steel
Connection	Ø 40 mm outlet, screw fit or solvent weld

# SLIM SHOWER

## Low-profile waste



This waste is compact (40 mm overall), and is specially designed for low profile shower trays. It is perfect for disabled showers.

### SLIM with trough outlet Ø 40/43



Reference	<b>WR30120026</b>
Ean-13 code	5017134129014
Packaging	Box
Multiple / Boxed qty	01/30
Height	40 mm
Flow L/Min (in 15 mm)	24 L/min, 25mm water seal
Grid / Dome	Chromed ABS dome

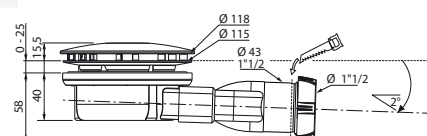
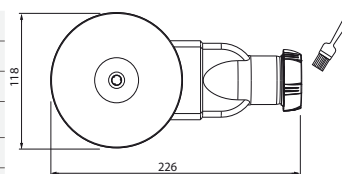

### JAMES METAL DOME outlet Ø 40

OUTLET SWIVELS 360°



Reference	<b>WR30720886</b>
Ean-13 code	3375537208111
Packaging	Box
Multiple / Boxed qty	01/18
Height	83 mm in horizontal position 123 mm in vertical position
Water seal	50 mm
Flow L/Min (in 15 mm)	27 L/min in horizontal position 34.5 L/min in vertical position
Grid / Dome	Metal dome

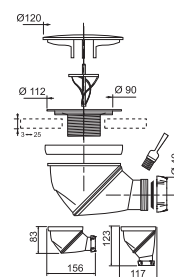



## Complete solutions for BATH wastes

► *Quick-Clac*



## Quick-Clac waste + self-cleaning trap



Reference	<b>WR34640001</b>
Ean-13 code	3375537140503
Packaging	Bag
Multiple / Boxed qty	01/30
Water seal	56 mm

### SPACE SAVING COBRA TRAP

- ▶ Fastest flow rate on the market - 63 L/m
- ▶ Self cleaning trap guaranteed not to block
- ▶ Space saving - only 108mm under bath

## Plug waste + swivelling trap + outlet adapter Ø 40



Reference	<b>WR34280101</b>
Ean-13 code	3375537126446
Packaging	Bag
Multiple / Boxed qty	01/30

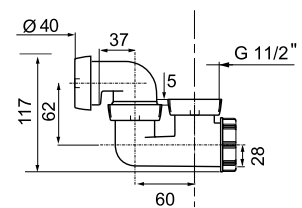

## Swivelling trap only



Reference	<b>WR30717611</b>
Ean-13 code	3375530116819
Packaging	Bag
Multiple / Boxed qty	01/60
Height under bath	117 mm
Water seal	50 mm
Flow rate l/min	57 L/min

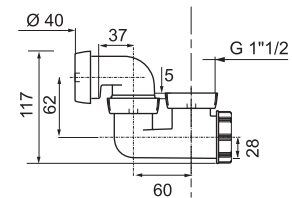

## ACCESSORIES

## Quick-Clac waste without overflow tube



Reference	<b>WRSP720099</b>
Ean-13 code	3375536007579
Packaging	Bag
Multiple / Boxed qty	01/150

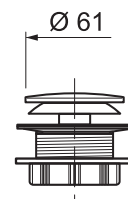

Contract range - Plastic bodied waste with stainless steel top





# A complete range of drain systems for SINKS

any material and any type of configuration

- ▶ *Wastes*
- ▶ *Complete kits*
- ▶ *Traps*
- ▶ *Connecting tubes*



## Stainless steel basket WASTE and rectangular overflow



Reference	<b>WR30720488</b>
Ean-13 code	3375537204113
Packaging	Branded bag
Multiple / Boxed qty	01/15
Waste	Basket

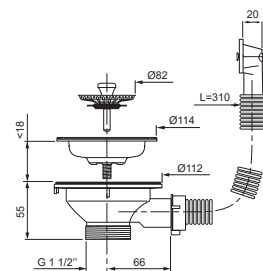

## Stainless steel basket WASTE with round overflow



Reference	<b>WR30720429</b>
Ean-13 code	3375537203543
Packaging	Branded bag
Multiple / Boxed qty	01/30
Overflow	With round grid
Waste	Basket

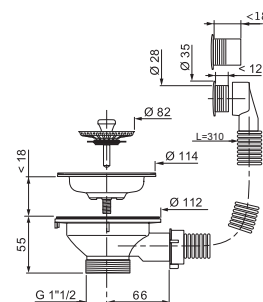

## Stainless steel basket WASTE



Reference	<b>WR30720426</b>
Ean-13 code	3375537203512
Packaging	Branded bag
Multiple / Boxed qty	01/60
Waste	Basket

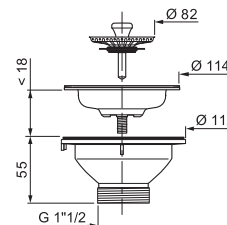

### Plug WASTE for sinks Ø 60 mm



Reference	<b>WR30720405</b>
Ean-13 code	3375537203314
Packaging	Printed bag
Multiple / Boxed qty	01/60
Waste	Plug with chain 300 mm

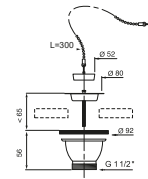

### Plug WASTE for sinks Ø 50 mm



Reference	<b>WR30720404</b>
Ean-13 code	3375537203307
Packaging	Printed bag
Multiple / Boxed qty	01/100
Waste	Plug with chain 250 mm

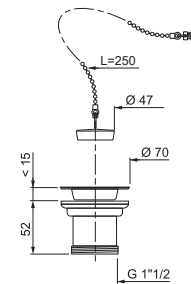

# WIRQUIN NEO and WIRQUIN NEO AIR Zero leak trap!



**AIR**  
FUNCTION AIR SYSTEM



## Product advantages

- + **Overmoulded seals:** bi-injection technology. There is no risk of leakage or lost seals!
- + **QUICK-SAFE FUNCTION:** 1/4 turn captive nut with overmoulded seal. Quick, reliable installation.
- + **AIR SYSTEM FUNCTION:** optional, air vent system built into the product with the same performance as a standard product.

WIRQUIN NEO AIR, allows the pipes to be ventilated: when negative pressure is created in the pipework, the WIRQUIN NEO AIR membrane opens, providing ventilation to prevent suction of the water seal.

### WIRQUIN NEO AIR trap Ø 1 1/2"



NEW



Reference	<b>WR30722168</b>
Ean-13 code	3375537220694
Packaging	Sleeve
Multiple / Boxed qty	01/65
Water seal	50 mm
Height	145 to 205 mm

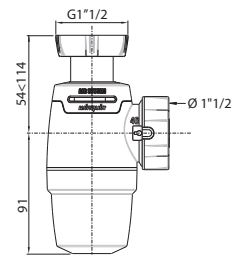

### WIRQUIN NEO AIR trap Ø 1 1/2" + washing machine connector



NEW



Reference	<b>WR30120439</b>
Ean-13 code	3375537220687
Packaging	Bag
Multiple / Boxed qty	01/45
Water seal	50 mm
Height	181 to 229 mm

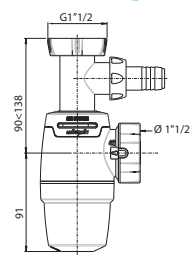

### WIRQUIN NEO trap Ø 1 1/2"

NEW



Reference	<b>WR30722166</b>
Ean-13 code	3375537220632
Packaging	Sleeve
Multiple / Boxed qty	01/65
Water seal	50 mm
Height	145 to 205 mm

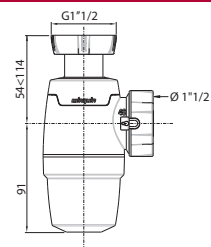

### WIRQUIN NEO trap Ø 1 1/2" + washing machine connector

NEW



Reference	<b>WR30120429</b>
Ean-13 code	3375537220625
Packaging	Bag
Multiple / Boxed qty	01/50
Water seal	50 mm
Height	181 to 229 mm

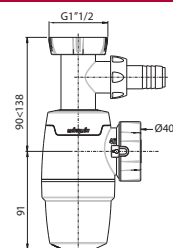

### ESPACE LOW-PROFILE TRAP for single sinks + washing machine connector



Reference	<b>WR31000201</b>
Ean-13 code	3375536009627
Packaging	Bag
Multiple / Boxed qty	01/07
Washing machine connector	Yes
Height under sink	166 to 211 mm
	50mm Seal

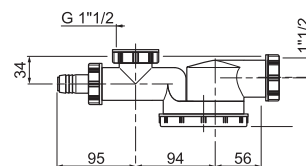

### ESPACE low-profile TRAP for double sinks + extension



Reference	<b>WR33000203</b>
Ean-13 code	3375536023982
Packaging	Bag
Multiple / Boxed qty	01/30
Washing machine connector	Yes
Extension	200 mm
Centreline distance	380 to 500 mm

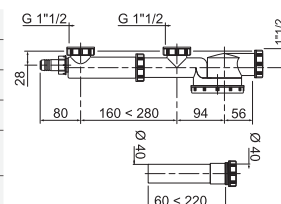



# A complete range of drain systems for **WASHBASINS**

- ▶ *Complete kits*
- ▶ *Traps*
- ▶ *Wastes*
- ▶ *Overflow connectors*
- ▶ *Connecting tubes*



# XS PURE Reinvent your space



## Product advantages

- + **Space saving:** ultra-compact system! Frees up space under the basin.
- + **Easy to clean:** the trap can be cleaned from above thanks to its anti-odour cartridge for quick and easy cleaning.
- + **Easy to install:** washer integrated into a 1/4 turn nut for quick and easy installation!

## XS PURE Quick-Clac free flow Ø 32



\* Now with solid dome

Reference	<b>WR30721531</b>
Ean-13 code	3375537214617
Packaging	Plastic blister box
Multiple / Boxed qty	01/14

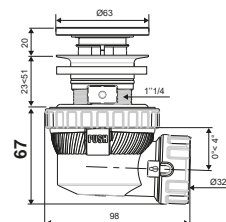

## Cartridge for XS PURE/NANO 6.7 free flow



Reference	<b>WR30721991</b>
Ean-13 code	3375537219100
Packaging	Bag
Multiple / Boxed qty	01/65

## Dome for XS PURE/NANO 6.7 Quick-Clac



\* Now with solid dome

Reference	<b>WR30721992</b>
Ean-13 code	3375537219117
Packaging	Bag
Multiple / Boxed qty	01/54



# WIRQUIN NEO and WIRQUIN NEO AIR Zero leak trap!

## WIRQUIN NEO AIR TRAP Ø 1 1/4"



NEW



Reference	<b>WR30722169</b>
Ean-13 code	337553720717
Packaging	Sleeve
Multiple / Boxed qty	01/65
Water seal	50 mm
Height	145 to 205 mm

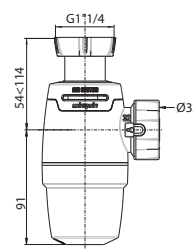

## WIRQUIN NEO TRAP Ø 1 1/4"

NEW



Reference	<b>WR30722167</b>
Ean-13 code	3375537220656
Packaging	Sleeve
Multiple / Boxed qty	01/65
Water seal	50 mm
Height	145 to 205 mm

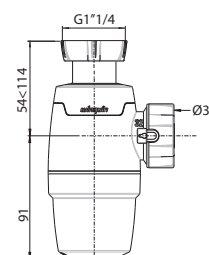

## LINÉIS brass TRAP



Reference	<b>WR30120018</b>
Ean-13 code	3375539057779
Packaging	Box
Multiple / Boxed qty	01/15
Water seal	50 mm
Flow rate L/min	42 L/min
Height	137 to 230 mm

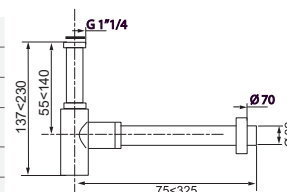

## LINÉIS brass mini TRAP



Reference	<b>WR30718071</b>
Ean-13 code	3375537135240
Packaging	Box
Multiple / Boxed qty	01/10
Water seal	10 mm
Flow rate L/min	40 L/min
Height	100 to 150 mm

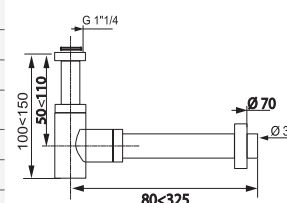



## Brass Quick-Clac push top WASTE

Contract range - Plastic bodied waste



Reference	<b>32500301</b>
Ean-13 code	3375539043147
Packaging	Bag
Multiple / Boxed qty	01/84
Overflow	Yes
Plug	Chromed brass
Waste body	Chromed plastic

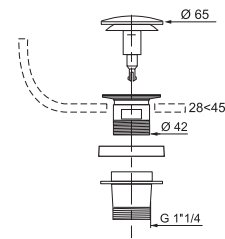

## Stainless steel Quick-Clac push top WASTE

Contract range - Plastic bodied waste



Reference	<b>WR32500301</b>
Ean-13 code	3375539064265
Packaging	Bag
Multiple / Boxed qty	100
Overflow	Yes
Plug	Chromed stainless steel
Waste body	White plastic

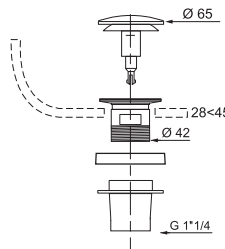

## Brass Quick-Clac WASTE without overflow



Reference	<b>WR32140001</b>
Ean-13 code	3375539058196
Packaging	Box
Multiple / Boxed qty	01/40
Height	75 mm

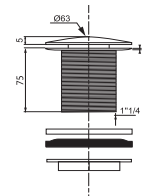

## Brass Quick-Clac WASTE



Reference	<b>WR30720507</b>
Ean-13 code	3375537204304
Packaging	Box
Multiple / Boxed qty	01/20
Slot	Yes

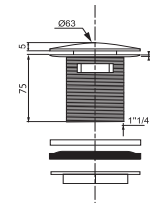

## Flip-top WASTE without overflow



Reference	<b>WR32050301</b>
Ean-13 code	3375539063671
Packaging	Box
Multiple / Boxed qty	01/36
Slot	No
Height	75 mm

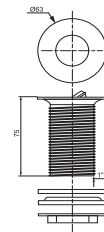

## Brass flip-top WASTE



Reference	<b>WR32050001</b>
Ean-13 code	3375539054044
Packaging	Box
Multiple / Boxed qty	01/40
Slot	Yes
Height	75 mm

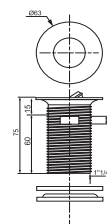



# All types of **CONNECTORS** and **ACCESSORIES** for easy home improvement projects

► *Magicflex connectors*

# UNIVERSAL MAGICFLEX

## A single product for all your needs



The standard product is Female-Female but can be changed to Male-Female by cutting one end or Male-Male by cutting both ends of the Magicflex.

### Product advantages

- + Flexible
- + 1 single model instead of 3.
- + No need for corner calculations.
- + Solvent weld.

### Universal MAGICFLEX, solvent weld



#### Ø 1 1/4"

Reference	<b>WR79009007</b>
Ean-13 code	3375539049712
Packaging	Bulk
Multiple / Boxed qty	10/130
Features	Ø 1 1/4" female Can be cut to Ø 1 1/4" mm male

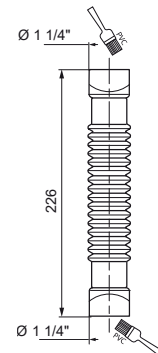

#### Ø 1 1/2"

Reference	<b>WR79008006</b>
Ean-13 code	3375539048340
Packaging	Bulk
Multiple / Boxed qty	10/90
Features	Ø 1 1/2" mm female Can be cut to Ø 1 1/2" mm male

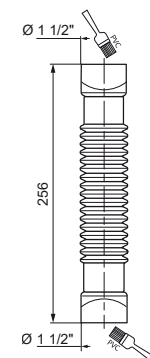

## Pipe CONNECTOR



**Ø 40 MM x Ø 32 MM**

Reference	<b>WR79294001</b>
Ean-13 code	3375536026167
Packaging	Bag with header
Multiple / Boxed qty	01/200

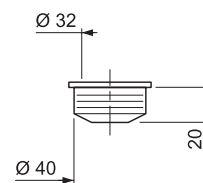

## Female REDUCER



**1 1/4" - MALE 1 1/2"**

Reference	<b>WR39450001</b>
Ean-13 code	3375536022800
Packaging	Bag with header
Multiple / Boxed qty	01/100

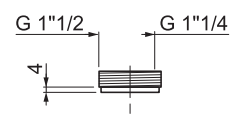

## Female REDUCER



**40mm - MALE 1 1/2"**

Reference	<b>WR39452001</b>
Ean-13 code	3375536022800
Packaging	Loose
Multiple / Boxed qty	01/100

**32mm - MALE 1 1/4"**

Reference	<b>WR39452002</b>
Ean-13 code	3375536022800
Packaging	Loose
Multiple / Boxed qty	01/100

# Universal Plug

UPPY



► The smart 2 in 1 plug for kitchen and bathroom!

## ► 2 IN 1 PLUG



## ► A SMART PRODUCT

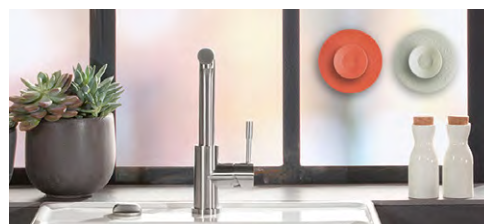

## ► UNIVERSAL PRODUCT FOR DEFECTIVE PLUGS - Ø110MM



## ► EASY TO CLEAN

WR30722894

Description	Reference	EAN code	Packaging	Multiple/Packaging
UPPY BLACK	WR30722894	3375537222544	Blister	42



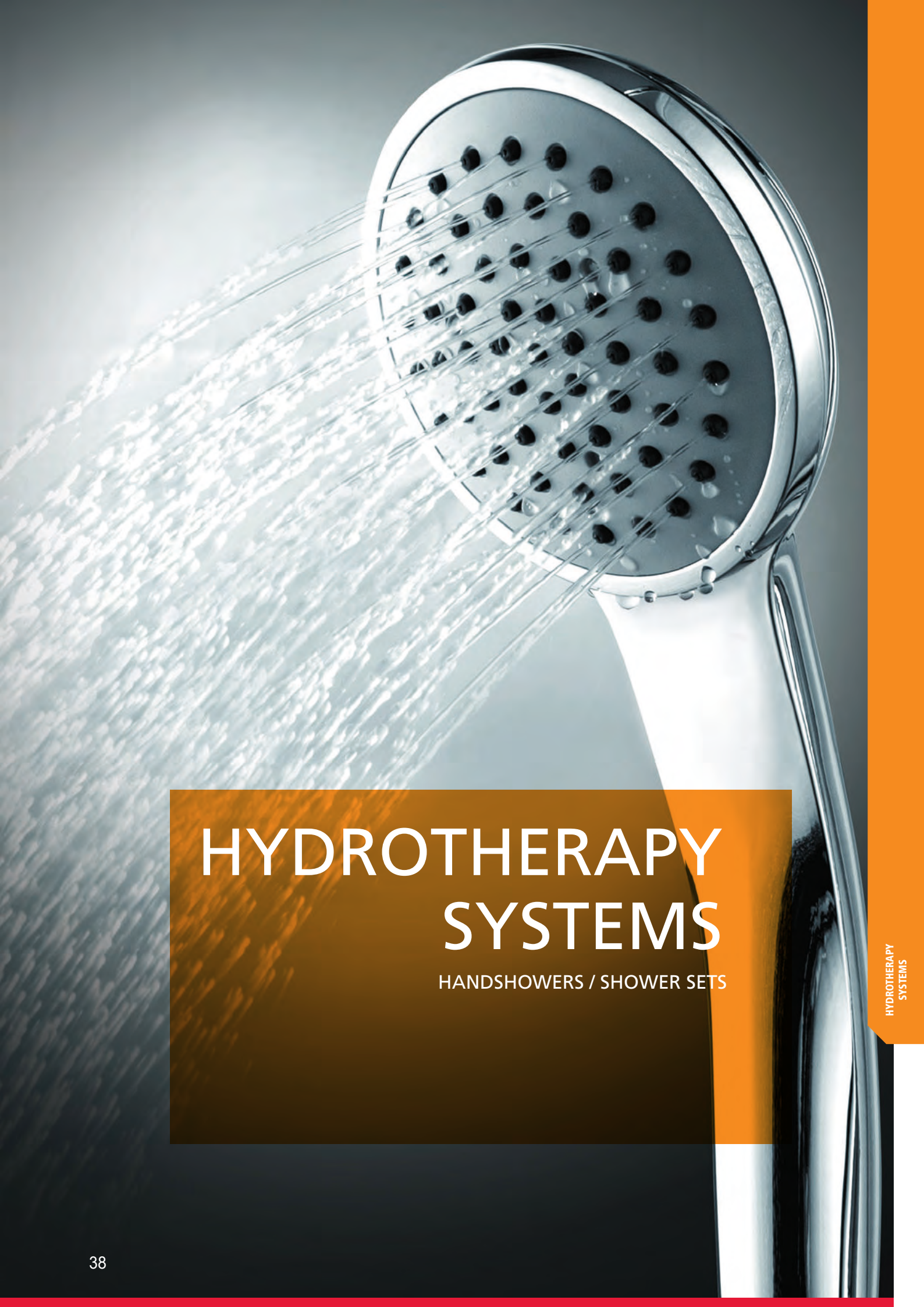

# HYDROTHERAPY SYSTEMS

HANDSHOWERS / SHOWER SETS

HYDROTHERAPY  
SYSTEMS

## ZEN bar



Reference	<b>WR60720880</b>
Ean-13 code	3375537208050
Packaging	Blister
Multiple / Boxed qty	01/10
Handshower	▶ 4 jets + stop jet. ▶ Ø 10 cm.
Flexible hose	▶ Chromed stainless steel Power Metal. ▶ 1.50 m.
Shower bar	▶ Adjustable bar Ø 25 mm. ▶ Chromed stainless steel.
Nuts	▶ Chromed brass tap nut. ▶ Chromed ABS handshower nut.

## ROSA



Reference	<b>WR60720563</b>
Ean-13 code	3375537204878
Packaging	Freedom
Multiple / Boxed qty	01/16
Handshower Number of jets	▶ 3 jets: - Soft rain. - Drenching rain. - Massage.
Handshower diameter	Ø 12 cm
Material and finish	Chromed ABS

# Guarantee periods (excluding wear and tear parts)

## WC EQUIPMENT

### FLUSHING MECHANISMS/FLOAT VALVES

- All models 10 years
- Accessories, spare parts 2 years

### TOILET SEATS

- All models *with exception of the special cases below* 2 years
- MODUFIX toilet seats 5 years
- Spare parts 2 years

### SUPPORT FRAMES

- All models 10 years
- Accessories 2 years

### CISTERNS

- All models 10 years
- Accessories and spare parts 2 years

### WC CONNECTORS

- All models 2 years
- Accessories and spare parts 2 years

## DRAINAGE SYSTEM

### WALK-IN-SHOWER

- Waste JAMES and SLIM for installation on screed 10 years
- All models 5 years
- Accessories 2 years

### WASTES

- All models *except special cases below* 2 years

#### Shower wastes :

- JAMES, SLIM 5 years

- WIRQUIN NEO range 5 years
- ALL-IN-ONE range 5 years
- QUICK-CLAC bath and washbasin wastes 5 years
- ESPACE under sink kit 5 years
- NANO 6.7 range 5 years

- Accessories and spare parts 2 years

### FLOOR DRAINS

- All models 2 years

### WASTE CONNECTORS

- All models 2 years
- Magicflex flexible connectors 5 years

## HYDROTHERAPY

- All models 2 years
- Bathroom accessories 2 years



